

DREMEL[®]

Variable Speed
Moto-Tool

Model 370

- For hobby, craft & do-it-yourself jobs
- 5,000 to 25,000 RPM
- Variety of attachments



GRIND • DRILL • ENGRAVE
CARVE • SAND • POLISH
BUFF • SAW • SHARPEN
DEBURR • ROUT & MORE!

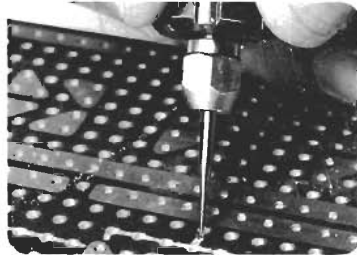
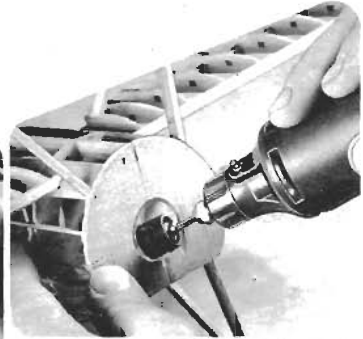

DREMEL[®] • Division of Emerson Electric Co. 4915 21st Street • Racine, Wisconsin 53406

SAFETY

- 1 KEEP WORK AREA CLEAN**
Cluttered areas and benches invite accidents.
- 2 AVOID DANGEROUS ENVIRONMENT**
Don't expose tools to rain. Don't use power tools in damp or wet locations. Don't use power tools in flammable or explosive atmospheres. Avoid chemical or corrosive environments. Keep work area well lit.
- 3 KEEP CHILDREN AWAY**
All visitors should be kept safe distance from work area.
- 4 STORE IDLE TOOLS**
When not in use, tools should be stored in dry, high or locked-up place — out of reach of children.
- 5 DON'T FORCE TOOL**
It will do the job better and safer at the rate for which it was designed.
- 6 USE RIGHT TOOL**
Don't force small tool or attachment to do the job of a heavy-duty tool.
- 7 WEAR PROPER APPAREL**
No loose clothing or jewelry to get caught in moving parts. Rubber gloves and footwear are recommended when working outdoors.
- 8 USE SAFETY GLASSES**
Use safety glasses with most tools. Also face or dust mask if cutting operation is dusty.
- 9 DON'T ABUSE CORD**
Never carry tool by cord or yank it to disconnect from receptacle. Keep cord from heat, oil, and sharp edges.
- 10 SECURE WORK**
Use clamps or a vise to hold work. It's safer than using your hand and it frees both hands to operate tool.
- 11 DON'T OVER-REACH**
Keep proper footing and balance at all times.
- 12 MAINTAIN TOOLS WITH CARE**
Keep tools sharp and clean for best and safest performance. Follow instructions for lubricating and changing accessories.
- 13 DISCONNECT TOOLS**
When not in use; before servicing; when changing accessories, such as: blades, bits, cutters, etc.
- 14 REMOVE ADJUSTING KEYS AND WRENCHES**
Form habit of checking to see that keys and adjusting wrenches are removed from tool before turning it on.
- 15 AVOID ACCIDENTAL STARTING**
Don't carry plugged-in tool with finger on switch. Be sure switch is OFF when plugging in.
- 16 OUTDOOR USE EXTENSION CORDS**
When tool is used outdoors, use only extension cords suitable for use outdoors and so marked.
- 17 BE ALERT**
Don't use power tools when tired or fatigued. Don't use power tools after taking drugs, alcohol or medications.

2

GROUNDING INSTRUCTIONS

This tool should be grounded while in use to protect the operator from electric shock. The tool is equipped with an approved three-conductor cord and three-prong grounding type plug to fit the proper grounding type receptacle. The green (or green and yellow) conductor in the cord is the grounding wire. Never connect the green (or green and yellow) wire to a live terminal. If your unit is for use on less than 150 volts, it has a plug like that shown in **Figure A**. If it is for use on 150 to 250 volts, it has a plug like that shown in **Figure D**. An adapter, **Figures B and C**, is available for connecting **Figure A** plugs to two-prong receptacles. The green-colored rigid ear, lug, etc., must be connected to a permanent ground such as a properly grounded outlet box. No adapter is available for a plug as shown in **Figure D**. Adapter's not allowed in Canada by the Canadian electrical code.

Use only three-wire extension cords which have three-prong grounding-type plugs and three-pole receptacles which accept the tool's plug. Replace or repair damaged or worn cords immediately.

Replacement Parts

When servicing use only identical replacement parts.

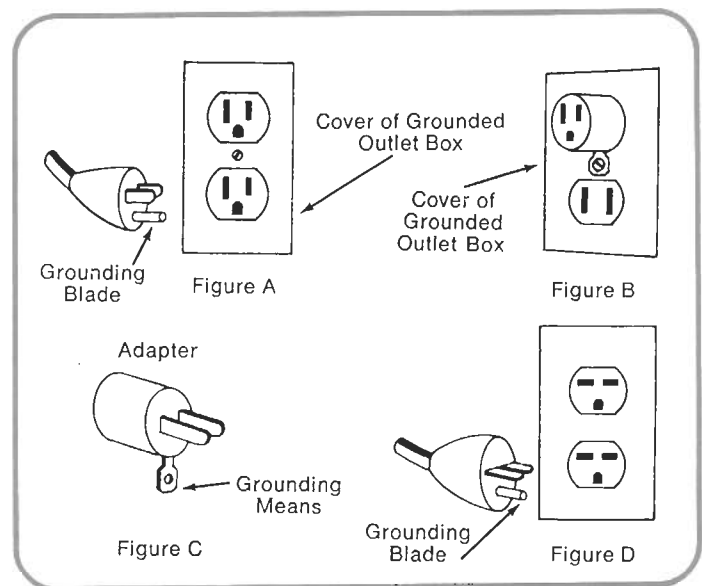

CURRENT

Tool operates on 115V, AC, 60-Hz.

OPERATION / MAINTENANCE



ALWAYS UNPLUG MOTO-TOOL WHEN CHANGING COLLETS OR INSERTING ACCESSORIES

To achieve the best results when working on different kinds of materials, the speed of your Moto-Tool should be regulated. Use your built-in Speed Control Switch to select the desired speed for the material you are working with.

CHUCK — Consists of chuck cap and collet. *Do not attempt to operate chuck lock pin while Moto-Tool is running.* Depress chuck lock pin and rotate chuck cap by hand until lock pin snaps into place and stops the chuck cap from turning.

Place chuck wrench over chuck cap and loosen as shown in the illustration below. The chuck lock pin must be kept depressed during this operation. Any accessory or drill should

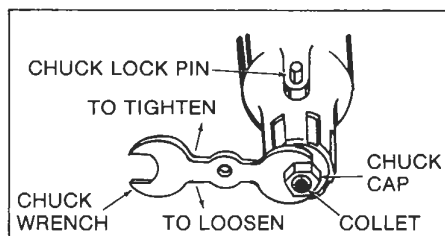

be inserted into the collet as far as possible to prevent wobble during operation. Now tighten chuck cap as shown keeping lock pin depressed. Avoid excessive tightening of the chuck cap.

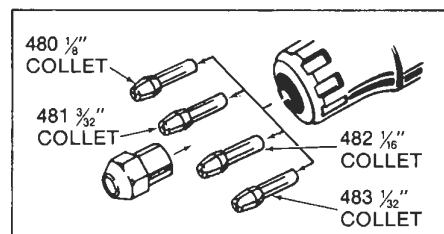

COLLETS — Four collets are available for each Moto-Tool model (see page 14). Each has a different hole diameter in order to accept various accessory shank and drill sizes. To insert a different collet, follow chuck loosening instructions. After chuck cap is loosened, continue to unscrew until it comes off. Remove collet (it should drop out easily by tipping the Moto-Tool). Insert the collet desired and replace chuck cap. Choose the right collet for the accessory shank or drill size. Never try to force a larger diameter shank or drill into a smaller size collet opening. Each Dremel collet has a size range which is indicated in the illustration above.

4

MAINTENANCE BRUSHES — Check brushes for wear every 20 hrs. Brushes can be found under the two screw caps near the cord end of the Moto-Tool. When brushes have worn to approximately $\frac{1}{8}$ " from the springs they should be replaced only with the Dremel Moto-Tool brushes specified for your particular model. Brushes which have been checked and are not worn enough to require replacement should be put back into the Moto-Tool in the same holder from which they were removed. When inserting new brushes, make sure the curved brush ends conform to the curvature of the commutator.

CAUTION: Any other servicing of this tool should be performed by an authorized service representative.

BALANCING ACCESSORIES — For precision work, it is important that all accessories be in perfect balance (much the same as the tires on your automobile). To true up or balance an accessory, slightly loosen collet cap and give the accessory or collet a $\frac{1}{4}$ " turn. Retighten collet cap and run the Moto-Tool. You should be able to tell by the sound and feel if your accessory is running in balance. Continue adjusting in this fashion until perfect balance is achieved. To maintain balance on abrasive wheel points, before each use, with the wheel point secured in the chuck, turn on the Moto-Tool and run the No. 415 Dressing Stone (see Page 14) lightly against the revolving wheel

point. This removes high spots and trues up the wheel point for perfect balance.

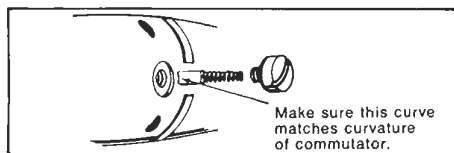

BEARINGS — Moto-Tool Nos. 245, 250, 258, 260, 270, & 370 are equipped with oil impregnated sleeve bearings. Nos. 280 and 380 have double ball bearing construction that never requires additional oiling.

IMPORTANT

Use of any accessories or attachments other than those supplied by Dremel may be hazardous.

For additional replacement part sheets, write the Dremel Service Center, P.O. Box 954, Racine, Wis. 53405.

WHEEL DIAMETER — *Do not use* grinding wheels over 1" in diameter. Moto-Tool's high speed can cause larger wheels to fly apart and could cause injury.

DIAL THE SPEED TO FIT THE JOB — Different materials such as hard wood, plastics and metals all require different speeds. Take a practice piece to perfectly match Moto-Tool speeds to the material and accessory you are using.

Dial slow speeds for delicate projects . . . working with soft plastics, shells, eggery, intricate wood carvings, fragile model parts, or when polishing with a wire brush.

Dial faster speeds for routing signs, shaping edges, dado or rabbeting. Certain woods, metals, glass engravings and drilling require faster speeds.

Just select the right speed for each job.

SAFETY — Protect your eyes when grinding or routing with the Moto-Tool . . . *always wear an approved type of safety glasses.*

A REMINDER: We suggest that you read this manual over carefully for it will help you in the selection of the correct accessory for the job at hand.

Remember, your new Dremel Moto-Tool is the finest power tool of its kind. But its performance is only as good as the accessories with which it is used. For best results use Dremel accessories. We hope you'll enjoy many years of trouble free pleasure from your Dremel Moto-Tool.

5

HIGH SPEED CUTTERS

Dremel High Speed Cutters have a limitless number of uses, particularly in hobby, crafts and Do-It-Yourself applications. There's a cutter shape to fit most every application.

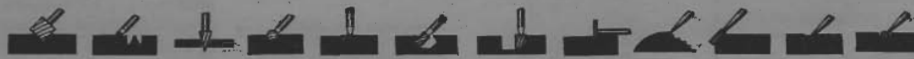
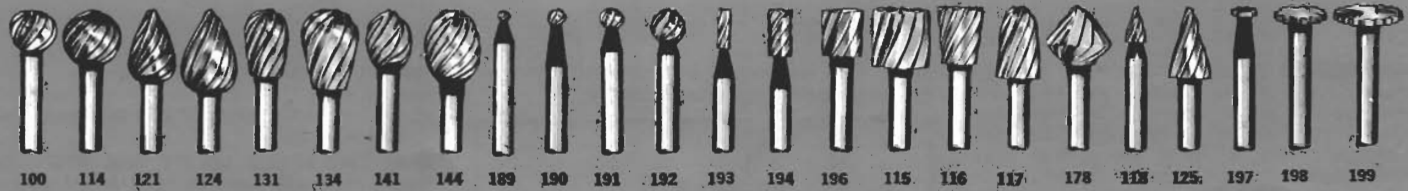

Typical cutter applications

DO NOT USE AT SPEEDS IN EXCESS OF 30,000 RPM

High speed cutters are ideal for many hobby, craft jobs. Use them for carving, cutting, slotting and countersinking in wood, or plastics and in soft metals. They are particularly useful for freehand or precision routing in wood or plastics.

Tungsten carbide cutters are designed for extremely long cutting life. Use on hardened steel, fired ceramics, and other hard materials. Engrave permanently on tools and garden equipment.

Small engraving cutters are ideal for intricate work on ceramics (greenware), wood carvings, jewelry, and scrimshaw—and on complicated printed circuit boards. Use these on wood, plastics, and soft metals. Do not use on steel or other hard materials.



Shape wax models



Finish wax models



Grind cast rings



Carve wood



Rout wood



Remove putty

6

TUNGSTEN CARBIDE CUTTERS

Outlast high speed cutters many times over. 1/8" shanks, maximum cutting heads of 1/8".

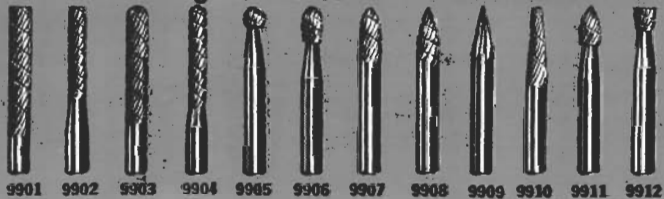

DO NOT USE AT SPEEDS IN EXCESS OF 30,000 RPM

SMALL ENGRAVING CUTTERS

3/32" shanks. (3/32" collet required)



Remove flash



Enjoy scrimshaw



Detail ceramics



Engrave metal

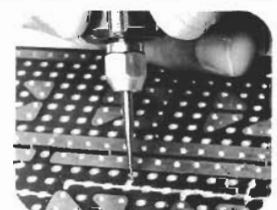

Work on printed circuits



Decorate frames



Engrave tools



Carve wood reliefs



Contour edges



Shaping

7

EMERY WHEEL POINTS 1/8" shanks. Made of the highest quality abrasives-

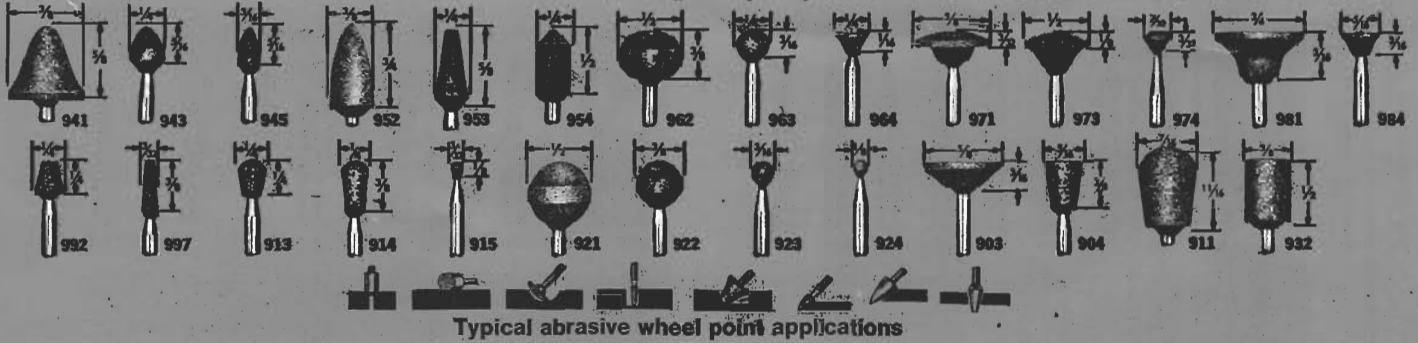

Typical abrasive wheel point applications

Abrasive wheel points—Dremel mounted wheel points are made of the highest quality abrasives available. There is a size and a shape available for virtually every possible grinding application. They are ideal for sharpening lawn mower blades, chain saws, screwdriver tips, knives, scissors, chisels, and other cutting tools. Use them for removing flash from metal castings, smoothing welded joints, grinding off rivets, deburring gears and other metal parts.

Silicon grinding points are designed for use on hard metals, and are handy for grinding on hardened steel gun sights, hammers and trigger housings. Perfect for removing stilt marks and excess glaze on ceramics, and engraving on glass.



Sharpen edges



Grind flash

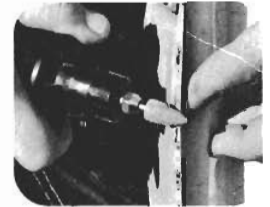

Remove rust



Sharpen augers

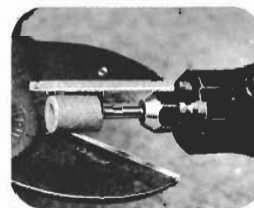

Sharpen tools



Shape radii

8

PLAIN SHAPED WHEEL POINTS



Shape No.	Dia.	Thickness	Shape No.	Dia.	Thickness
8143	1/8"	1/8"	8173	3/8"	1/8"
8144	1/8"	1/4"	8174	3/8"	1/4"
8145	1/8"	3/8"	8175	3/8"	3/8"
8146	1/8"	1/2"	8176	3/8"	1/2"
8149	5/32"	1/4"	8181	1/2"	1/16"
8151	3/16"	1/8"	8182	1/2"	1/8"
8152	3/16"	1/4"	8183	1/2"	1/4"
8153	3/16"	3/8"	8184	1/2"	3/8"
8154	3/16"	1/2"	8191	5/8"	1/8"
8157	1/4"	1/16"	8193	5/8"	3/8"
8158	1/4"	1/8"	8200	3/4"	1/8"
8159	1/4"	3/16"	8202	3/4"	3/8"
8160	1/4"	1/4"	8215	1"	1/8"
8162	1/4"	3/8"			
8163	1/4"	1/2"			

All have 1/8" shanks.

NOT USE SPEEDS EXCESS OF 10,000 RPM



Typical plain shaped wheel point applications

DO NOT USE 8202 AT SPEEDS IN EXCESS OF 30,000 RPM

SILICON GRINDING POINTS

Made especially for working on hard materials.



83142 83322 83642 83762 84382 84642 84922 85342 85422 85562 85602 85622

DO NOT USE AT SPEEDS IN EXCESS OF 30,000 RPM



Typical silicon grinding point applications



Grind close tolerances



Shape models



Ship building



Grind off excess material



Building doll houses



Sharpen taps



Remove flash



Work on model engines



Finishing carvings



Grind gun sights

9

DO NOT USE AT SPEEDS IN EXCESS OF 30,000 RPM

POLISHING ACCESSORIES

There's a Dremel polishing accessory for every need...



Polishing Point No. 427
Fits Mandrel No. 424



Polishing Wheel No. 425
Fits Mandrel No. 402.

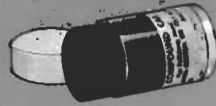

Polishing Compound No. 421



Cloth Polishing Wheel
No. 423
Fits Mandrel No. 402.



Felt Polishing Tip No. 422
Fits Mandrel No. 401.



Felt Polishing Wheels
1/2" dia. No. 414
1" dia. No. 429
Fits Mandrel No. 401.

DO NOT USE AT SPEEDS IN EXCESS OF 30,000 RPM

Polishing accessories are available in a variety of shapes and materials to match your needs. Metal surfaces can be polished to a high luster with the impregnated polishing accessories Nos. 425 and 427. They can be shaped to fit the job with the dressing stone No. 415. Cloth and felt polishing accessories are ideal for polishing plastics, metals, and jewelry. Use with polishing compound No. 421.

Sanding accessories can be used for sanding, shaping, and contouring. Handy for use on wood, fiber glass, and plastics. Sand flat, curved, and beveled shapes with drum sander No. 407 and sanding discs 411, 412, and 413.



Polish silverware



Polish stones



Polish metal



Brighten jewelry



Polish model trim



Carve gem stones

10

SANDING ACCESSORIES

can be used for big or small jobs...



DRUM SANDER—No. 407

Ideal for rough shaping wood and smoothing fiber glass. Sander bands are replaceable in 1/2" sizes. Comes with one band. 3/8" shank.



Drum Sander Bands
1/2" dia. coarse grit—No. 408
1/2" dia. fine grit—No. 432



SANDING DISCS

No. 411—36 sanding discs, coarse, 3/4" dia.
No. 412—36 sanding discs, medium, 3/4" dia.
No. 413—36 sanding discs, fine, 3/4" dia.



MANDRELS

401—Screw Mandrel is used with polishing accessories.

402—Mandrel to be used with all cutting wheels, sanding discs and polishing wheels.

424—Screw Mandrel to be used with No. 427 polishing point.



DO NOT USE AT SPEEDS IN EXCESS OF 30,000 RPM



Detail wood carvings



Sand models



Smooth metal edges



Clean musical instrument



Polish metal surfaces

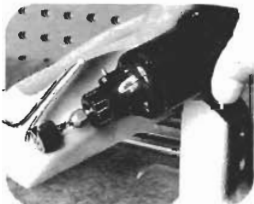

Contour wood



Finish plaster sculptures



Smooth rough edges



Drilling applications



Sand small areas

11

WIRE BRUSHES

1/8" shank wire brushes



*DO NOT USE 428, 442 & 443 AT SPEEDS IN EXCESS OF 15,000 RPM.

BRISTLE BRUSHES

1/8" shank bristle brushes



DO NOT USE AT SPEEDS IN EXCESS OF 30,000 RPM

Wire brushes are handy for removing rust and corrosion from shop and garden tools, metal surfaces such as door knobs, plates, marine, and automotive parts, connectors and forms can be polished to a bright finish.

Bristle brushes are ideal for cleaning in tight corners and hard to reach places. Silverware and jewelry can be cleaned and polished to a high luster. Antiques can be carefully cleaned and freed of paint-varnish build up.

Cutting wheel No. 409 can cut off frozen bolt heads and nuts in a hurry. Re-slot damaged bolt and screw heads for easy removal. Cuts rods, tubing and cables fast and easy.

Steel saws are perfect for slotting or cutting wood, fiber glass, plastics, and soft metals.



Clean spark plugs



Refinish furniture



Clean golf clubs



Remove rust

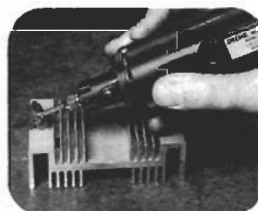

Polishing



Clean model engines

12

CUTTING WHEEL



CUTTING WHEEL No. 409

A handy emery wheel for slicing, cutting-off and similar operations. 36 discs per package. Fits Mandrel No. 402.

STEEL SAWS



STEEL SAWS No. 400 & 406

No. 406—.005" thick
No. 400—.015" thick

DO NOT USE AT SPEEDS IN EXCESS OF 30,000 RPM

Typical steel saw applications



Cut off metal



Cut thin fiber glass



Trim metal strips

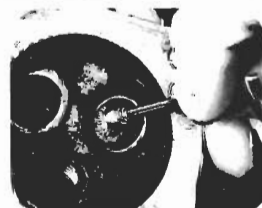

Polish machined surfaces

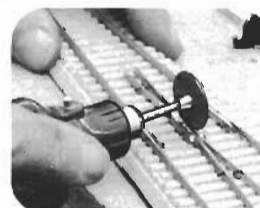

Cut model rails



Trim downspouts



Slot wood



Slot metal



Cut off bolts



Cut out eggshells

13

ADD FLEXIBILITY TO YOUR MOTO-TOOL WITH THESE TIME-SAVING ATTACHMENTS

MOTO-TOOL HOLDER No. 2217



Designed to hold the versatile Moto-Tool, the new DREMEL Moto-Tool Holder leaves both hands free to control the work piece. The sturdy swivel base can be mounted to the work surface. A simple twist of the base locking ring and the Moto-Tool can be adjusted to the exact position to fit the job. For Moto-Tool models 245, 260, 270, 280, 370 and 380.

ROUTER ATTACHMENT No. 229

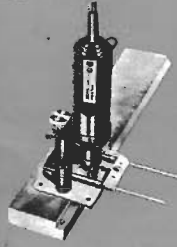

Mounts easily to Dremel Moto-Tool models 245, 260, 270, 280, 370, 380. Has calibrated depth control adjustment for precision routing and shaping. Edge guide can be quickly removed for free hand and surface routing. Fence adjusts from 0 to 2 3/8". For best results use Dremel high-speed router bits.

DRILL PRESS— No. 210



Perfect for precision drilling and routing. The press is only 12" high. Table can be raised or lowered. Locks in any position for accurate depth adjustment. Use with models 245, 260, 270, 280, 370 and 380.

SPEED CONTROLS No. 217 Foot-Operated



This Foot-Operated Speed Control leaves hands free for holding the power tool and work-piece. Controls Moto-Tool speeds from 0 to full RPM. The solid state 217 can also be used with drills, saws, sanders, soldering irons, glue guns and other power tools up to 5 amp rating. Lets you match the speed to the job.

No. 219 Hand-Operated



Ideal partner for the Moto-Tool, from 0 to full RPM. Just dial the right speed for your specific work. Can be used with a wide variety of power tools up to 5 amp rating, or as a dimmer for lighting. Solid state circuitry provides controlled full wave output.

Note: Speed Controls 217 and 219 should not be used with the Dremel Moto-Shop or Moto Tools 370-380.

DRESSING STONE No. 415



Dressed Emery Wheel Points cut faster and smoother. Size 3/8" square by 1" long.

HIGH SPEED ROUTER BITS

For routing, inlaying, mortising in wood and other soft materials. 1/8" shank. Use with Dremel router attachment. No. 229.

DO NOT USE AT SPEEDS IN EXCESS OF 30,000 RPM

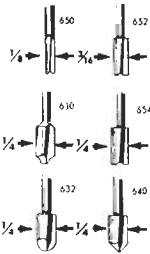

CHUCK COLLETS

For Moto-Tools Nos. 260, 270 & 280



No. 434—1/8"
No. 435—3/32"
No. 436—1/16"
No. 437—1/32"

For Moto-Tools Nos. 260 Series 55-3, 270 Series 66-2, 280 Series 66-2, Nos. 370, 380, and 245.



No. 480—1/8"
No. 481—3/32"
No. 482—1/16"
No. 483—1/32"

SAFETY GOGGLES No. 1228

Protect your eyes when grinding, cutting or carving. High quality for maximum front and side protection.



14

DREMEL LIMITED WARRANTY

Your Dremel Moto-Tool is warranted against defective material or workmanship for a period of one full year from date of purchase. But if for some reason trouble should develop, please do the following:

(1) Return the Moto-Tool prepaid direct to Dremel Service Center, P.O. Box 954, Racine, Wisconsin 53405

(2) Enclose a note telling us exactly what the problem is.

If our inspection shows that the trouble was caused by defective parts or workmanship, we will make all repairs free of charge and return prepaid to you. Repairs made necessary by normal wear, abuse, or out of warranty will be charged for at our regular low factory prices. We will try to return your repaired Moto-Tool to you within 72 hours after we receive it at the Dremel factory.

For prices and warranty fulfillment outside the continental United States, contact your local Dremel distributor.

THIS WARRANTY GIVES YOU SPECIFIC LEGAL RIGHTS, AND YOU MAY ALSO HAVE OTHER RIGHTS WHICH VARY FROM STATE TO STATE.

ADD THESE OTHER QUALITY DREMEL POWER TOOLS TO YOUR WORKSHOP

MOTO-SHOP®

MODEL NO. 572
The complete power workshop
— saw, sander, flexible
shaft tools



ELECTRIC ENGRAVER MODEL 290

- STEEL • GLASS • COPPER
- SILVER • BRASS • WOOD
- PLASTIC • CERAMIC
- ALUMINUM

Writes Like a Pencil
on Any Material



DREMEL® MOTO-TOOL MODEL 370 . . . SERIES 2

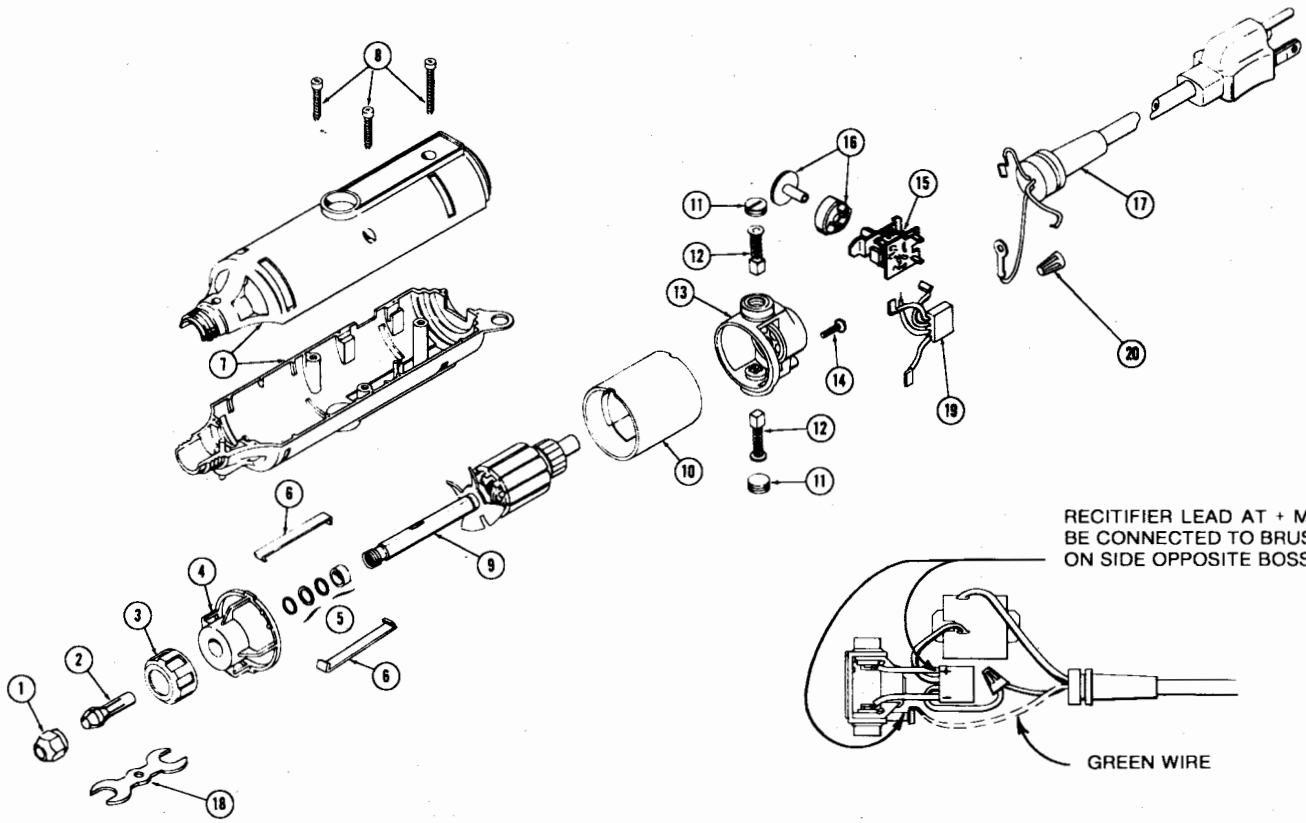

Qty.	Code No.	Part No.	Description
	1	660113	Chuck Cap
	2	480	1/8 Collet
		481	3/32 Collet
		482	1/16 Collet
		483	1/32 Collet
	3	660217	Housing Cap Screw
	4	990136	Front Brg. Brkt. (comp.)
	5	990816	Thrust Washer Assortment
	6	990805	Bearing Brkt. Clips (pr.)
	7	990605	Housing Complete
	8	990815	Housing Screws (3)
	9	990141	Armature w/Fan

Qty.	Code No.	Part No.	Description
	10	990112	Field w/Magnet
	11	990813	Brush Cap (pr.)
	12	990814	Brushes w/Shunts (pr.)
	13	990143	Rear Brg. Brkt. (comp.)
	14	828038	Ground Screw
	15	990615	Module w/Brkt.
	16	990819	Knob & Skirt Assem.
	17	660202	Cord
	18	500045	Wrench
	19	990616	Rectifier (comp.)
	20	660230	Wire Nut #A-2 (local Hdwe.)

WRITE FOR CURRENT PRICES - NO C.O.D.'S

UNITED STATES

Dremel Service Center, P.O. Box 954, Racine, WI 53405

OUTSIDE OF CONTINENTAL UNITED STATES

See your local distributor or write to Dremel Mfg. Co.
4915 Twenty-first St., Racine, Wis. 53406

EASTERN CANADA

Giles Tool Agencies, 47 Granger Ave., Scarborough, Ont.,
CANADA M1K 3L1

WESTERN CANADA

Totem Tools & Eq., Ltd., 3851 Main St., Vancouver, B.C.,
CANADA V5V-3P1

DREMEL® MFG. DIVISION
EMERSON ELECTRIC CO.
Form 660212 7-78

4915 21st STREET

RACINE, WISCONSIN 53406 U.S.A.

PRINTED IN U.S.A.