

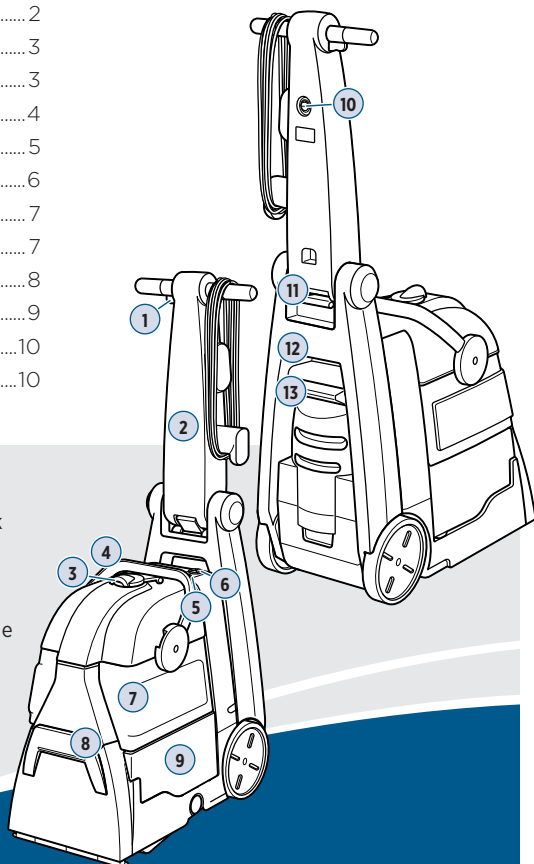

BIG GREEN DEEP CLEANING MACHINE

MODEL 86T3

Warranty	2
What's in the Box?	3
Cleaning Formulas	3
Filling the Clean Water Tank.....	4
Cleaning Your Carpet.....	5
Cleaning with Attachments.....	6
Emptying the Dirty Water Tank.....	7
Cleaning the Hose and Tools	7
Maintaining the Brush Roll and Belt.....	8
Removing & Replacing the Brush Roll.....	9
Storing Your Machine.....	10
Troubleshooting.....	10



Product Overview

- | | |
|-----------------------------|--------------------------|
| 1. Spray Trigger | 9. Clean Water Tank |
| 2. Adjustable Handle | 10. Power Switch |
| 3. Hose Latch | 11. Upper Handle Release |
| 4. Tank Carry Handle | 12. Back Carry Handle |
| 5. Solution Hose Connection | 13. Recline Handle |
| 6. Flow Indicator | |
| 7. Dirty Water Tank | |
| 8. Front Carry Handle | |



Go online for a comprehensive walkthrough of your new purchase!

This guide has everything you need to get ready for first use, including setting up, using and maintaining your machine, but online you'll find additional resources like tips and troubleshooting, videos, product registration, parts, and more. Go to support.BISSELL.com.

IMPORTANT SAFETY INSTRUCTIONS



READ ALL INSTRUCTIONS BEFORE USING YOUR APPLIANCE.

When using an electrical appliance, basic precautions should be observed, including the following:

WARNING

TO REDUCE THE RISK OF FIRE, ELECTRIC SHOCK OR INJURY:

- » Connect to a properly grounded outlet only. See grounding instructions. Do not modify the 3-prong grounded plug.
- » Do not leave appliance when it is plugged in. Unplug from outlet when not in use and before servicing.
- » Use indoors only.
- » Do not allow to be used as a toy. Close attention is necessary when used by or near children.
- » Do not use for any purpose other than described in this user guide. Use only manufacturer's recommended attachments.
- » Do not use with damaged cord or plug. If appliance is not working as it should, or has been dropped, damaged, left outdoors, or dropped into water, have it repaired at an authorized service center.
- » Always install float before any wet pick-up operation.
- » Do not unplug by pulling on cord. To unplug, grasp the plug, not the cord.
- » Do not pull or carry by cord, use cord as a handle, close a door on cord, or pull cord around sharp edges or corners. Do not run appliance over cord. Keep cord away from heated surfaces.
- » Do not unplug by pulling on cord. To unplug, grasp the plug, not the cord.
- » Do not handle plug or appliance with wet hands.
- » Turn OFF all controls before plugging or unplugging appliance.
- » Do not put any object into openings. Do not use with any opening blocked; keep openings free of dust, lint, hair, and anything that may reduce air flow.
- » Keep hair, loose clothing, fingers, and all parts of body away from openings and moving parts of the appliance and its accessories.
- » Use extra care when cleaning on stairs.
- » Do not use to pick up flammable or combustible materials (lighter fluid, gasoline, kerosene, etc.) or use in areas where they may be present.
- » Do not use appliance in an enclosed space filled with vapors given off by oil-based paint, paint thinner, some moth-proofing substances, flammable dust, or other explosive or toxic vapors.
- » Do not use to pick up toxic material (chlorine bleach, ammonia, drain cleaner, etc.).
- » Do not pick up anything that is burning or smoking, such as cigarettes, matches or hot ashes.
- » Use only BISSELL® cleaning products intended for use with this appliance to prevent internal component damage. See the Cleaning Formula section of this guide.
- » Unplug before connecting TurboBrush® Tool.
- » Do not immerse. Use only on surfaces moistened by the cleaning process.
- » Keep appliance on a level surface.
- » Do not use without intake screen filter in place.
- » Plastic film can be dangerous. To avoid danger of suffocation, keep away from children.
- » Do not pick up hard or sharp objects such as glass, nails, screws, coins, etc.
- » If your appliance has a motorized Brush Roll, do not leave machine running in the same spot without the handle fully upright.
- » Do not use without filters in place.
- » Liquid must not be directed towards equipment containing electrical components.
- » Use only the type and amount of liquids specified under the operations section of this guide.

SAVE THESE INSTRUCTIONS

THIS MODEL IS FOR HOUSEHOLD USE ONLY. COMMERCIAL USE OF THIS MACHINE VOIDS THE MANUFACTURER'S WARRANTY.

WARNING

Improper connection of the equipment-grounding conductor can result in a risk of electrical shock. Check with a qualified electrician or service person if you aren't sure if the outlet is properly grounded. DO NOT MODIFY THE PLUG. If it will not fit the outlet, have a proper outlet installed by a qualified electrician. This appliance is designed for use on a nominal 120-volt circuit, and has a grounding attachment plug that looks like the plug in the illustration. Make certain that the appliance is connected to an outlet having the same configuration as the plug. No plug adapter should be used with this appliance.

GROUNDING INSTRUCTIONS

This appliance must be connected to a grounded wiring system. If it should malfunction or break down, grounding provides a safe path of least resistance for electrical current, reducing the risk of electrical shock. The cord for this appliance has an equipment-grounding conductor and a grounding plug. It must only be plugged into an outlet that is properly installed and grounded in accordance with all local codes and ordinances.

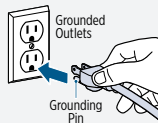



Warranty

» 5-Year limited warranty, may vary by state. Visit support.BISSELL.com or call 1-800-237-7691 for complete warranty information.

What's in the Box?

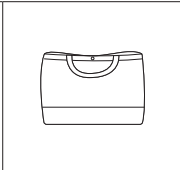
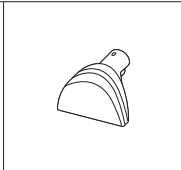
Standard accessories may vary by model. To identify what should be included with your purchase, please refer to the "Carton Contents" list located on the carton top flap.

				
Fully Assembled Machine	Hose	Storage Bag	6" Stair Tool	(3) Trial-Size BISSELL® Formulas (stored in the Dirty Water Tank)

Cleaning Formulas

View our family of carpet cleaning formulas for your family of mess-makers at [BISSELL.com](https://www.bissell.com).

Keep plenty of BISSELL formulas on hand so you can clean whenever it fits your schedule. Always use genuine BISSELL formulas in your machine. Other formulas may harm the machine and void the warranty. Do not use Hard Floor Formula on area rugs or carpet.

		
Clean + Refresh Powerful cleaning and odor elimination with Febreze freshness.	PET Stain & Odor Removes tough pet stains. <i>Includes StainProtect™ to protect against future stains.</i>	PRO MAX Clean + Protect Our most powerful formula for tough, ground-in dirt & stains. <i>Includes StainProtect to protect against future stains.</i>

Certain trademarks used under license from The Procter & Gamble Company or its affiliates.

Pretreat

Pretreat spots and stains to improve carpet cleaning performance.

		
PET Stain Pretreat Permanently removes tough pet stains. Removes odors with Enzyme Action.	PET PRO OXY Stain Destroyer Permanently removes tough pet stains. Removes pet odors with OXY.	PET Pretreat + Sanitize Penetrates to sanitize and loosen tough stains.

⚠️ WARNING To reduce the risk of fire and electric shock due to internal component damage, use only BISSELL cleaning formula intended for use with this machine.

Filling the Clean Water Tank

For additional tips and tricks on filling your Clean Water Tank visit support.BISSELL.com.



1. Remove the Dirty Water Tank. Pull handle to upright position and lift up to remove.

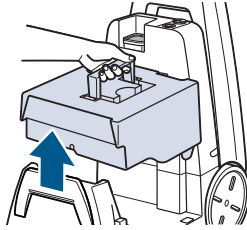

2. Lift Clean Water Tank from the base of machine.

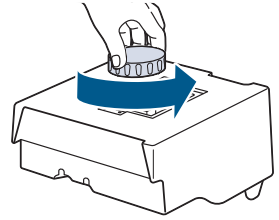

3. Remove cap. Fill tank to FILL line with hot tap water. Do not boil or microwave water.

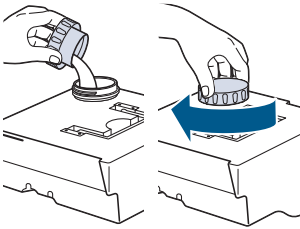

4. Use the cap on tank to measure BISSELL formula. Use two capfuls of formula for a full tank.

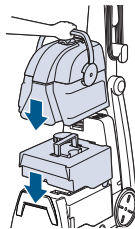

5. Replace the Clean Water Tank and Dirty Water Tank.

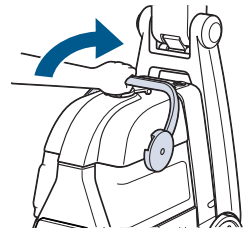

6. Push the Dirty Water Tank handle back to lock into place.

Cleaning Your Carpet

↖ We have additional tips for cleaning your carpet at support.BISSELL.com.

Carpet Cleaning Tips

- Before your first use, remove the cardboard cut out from the foot.
- Move furniture to another area if cleaning the entire room. (Optional)
- Vacuum area with a dry vacuum cleaner thoroughly before deep cleaning.
- Plan your cleaning route to leave an exit path. It is best to begin in the corner farthest from your exit.
- Pretreating is recommended to improve cleaning for heavily soiled carpet in high-traffic areas.
- Your machine has a circuit breaker that automatically shuts off the brush if a large or loose object gets caught in it. If that happens, unplug your machine, remove the object and plug machine in to reset the circuit breaker.
- You may notice hair and debris deposits on the carpet or in the tank that were loosened while cleaning (especially with newer carpets that have never been deep cleaned before). This debris should be picked up and thrown away.

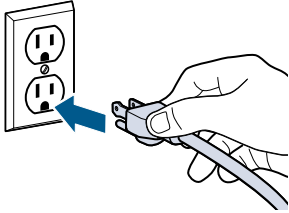
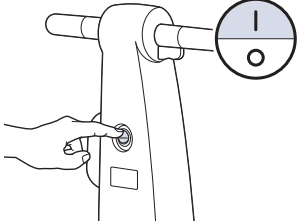
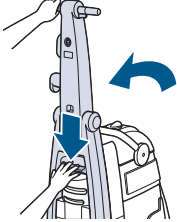
		
<p>1. Plug into a proper outlet.</p>	<p>2. Turn the Power Switch to the ON (I) position.</p>	<p>3. Recline handle by pushing down on the green lever on the back of the machine while pulling back on handle.</p>

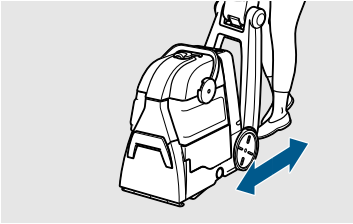
			
<p>4. Make cleaning passes. Repeat these passes until solution being pulled up appears clean.</p> <table><tr><td data-bbox="57 1166 263 1239"><p>1. Hold Spray Trigger</p><ul style="list-style-type: none">• 1 pass forward• 1 pass back</td><td data-bbox="325 1166 557 1239"><p>2. Release Spray Trigger</p><ul style="list-style-type: none">• 1 pass forward• 1 pass back</td></tr></table>		<p>1. Hold Spray Trigger</p> <ul style="list-style-type: none">• 1 pass forward• 1 pass back	<p>2. Release Spray Trigger</p> <ul style="list-style-type: none">• 1 pass forward• 1 pass back
<p>1. Hold Spray Trigger</p> <ul style="list-style-type: none">• 1 pass forward• 1 pass back	<p>2. Release Spray Trigger</p> <ul style="list-style-type: none">• 1 pass forward• 1 pass back		

⚠ WARNING To reduce the risk of injury, use extra care when cleaning on stairs. Keep machine on a level surface.

NOTICE Do not overwet. Take care not to run over loose objects or edges of area rugs. Stalling brush may result in premature belt failure. Some Berber carpets have a tendency to fuzz with wear. Repeated strokes in the same area with an ordinary vacuum or deep cleaner may aggravate this condition.

Cleaning with Attachments

Upholstery Cleaning Tips

If using to clean upholstery, check upholstery tags.

- Check manufacturer's tag before cleaning. "W" or "WS" on the tag means you can use your deep cleaning machine. If the tag is coded with an "X" or an "S" (with a diagonal stripe through it) or says "Dry Clean Only", do not proceed with any deep cleaning machine. Do not use on velvet or silk. If manufacturer's tag is missing or not coded, check with your furniture dealer.
- Check for colorfastness in an inconspicuous place.
- If possible, check upholstery stuffing. Colored stuffing may bleed through fabric when wet.
- Vacuum thoroughly to pick up loose debris and pet hair. Use a vacuum with a brush attachment and a crevice tool to clean in fabric folds.

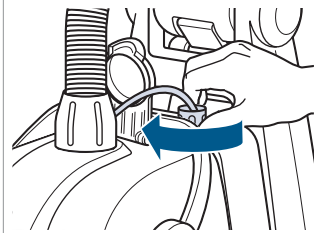

1. Connect solution hose to the hose connection point on machine, next to Flow Indicator. Insert hose and turn clockwise until locked into place.

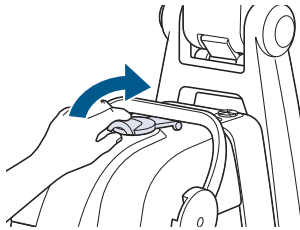

2. Open Hose Latch on the front of the machine and insert hose into place. Turn clockwise until locked into place.

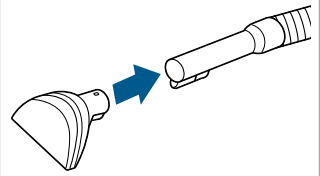

3. Attach the cleaning tool to the end of the hose.

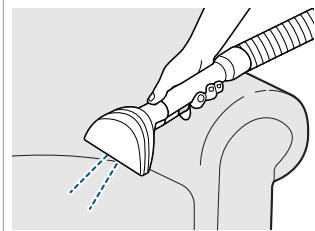

4. Clean by pressing the red trigger to spray solution onto the area to be cleaned. Slowly move the tool back and forth over the soiled surface.
Caution: Do not overwet.

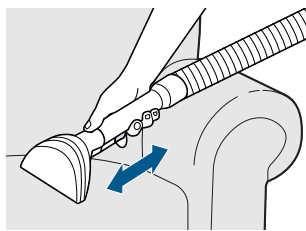

5. Release the trigger to suction soiled water. Continue to clean in the area, working in small sections, until no more dirt can be removed.

⚠ WARNING To reduce the risk of injury, use extra care when cleaning on stairs. Keep machine on a level surface.

Emptying the Dirty Water Tank

↖ We have additional tips for maintaining your machine at support.BISSELL.com.

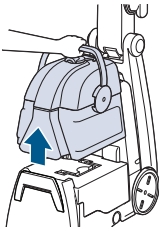

1. Remove the Dirty Water Tank by pulling the handle to the upright position and lift up. Carry the tank like a bucket to a utility sink or outside where you will dispose of the dirty water.

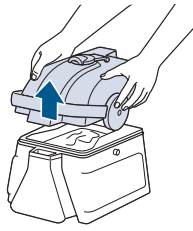

2. Unlatch the top of the tank from the bottom by pushing the handle all the way forward and lifting the top off. Pour dirty water into the sink.

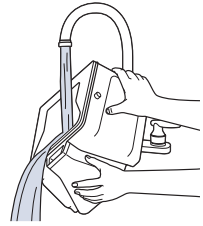

3. Rinse both parts of the Dirty Water Tank with warm tap water. The top half of the Dirty Water Tank can also be rinsed clean through the nozzle area.

Cleaning the Hose and Tools

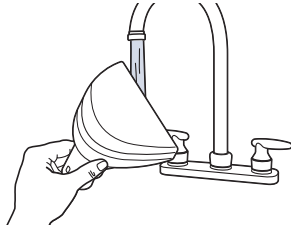

1. To clean attachments, remove from hose and rinse in clean, running water and let dry.

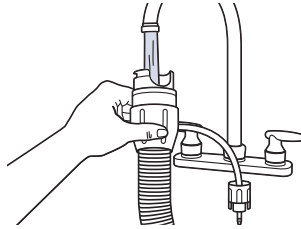

2. Clean the hose by removing it from the machine and running tap water through both ends.

⚠ WARNING To reduce the risk of electric shock, turn Power Switch OFF and disconnect plug from electrical outlet before performing maintenance or troubleshooting checks.

Maintaining the Brush Roll and Belt

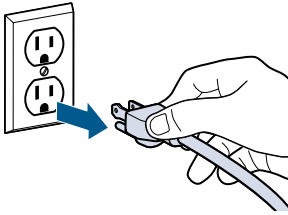

1. Turn OFF the machine and unplug it from the outlet.

Remove the Dirty and Clean Water Tanks from the base of the machine.

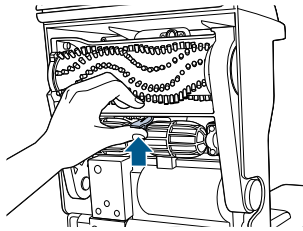

2. While standing behind the machine, lay it on its side.

Looking at the bottom of machine, find the back center of the brush carriage where the carriage latch is located. It is between the brush assembly and the front wheels.

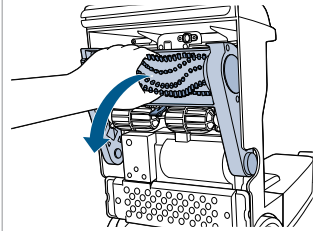

3. Pull brush carriage towards you with one hand until it stops, then pinch the carriage latch with other hand while pulling the carriage towards you. The carriage should swing out to access belt cover.

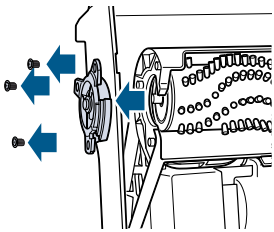

4. Remove three screws from cover.

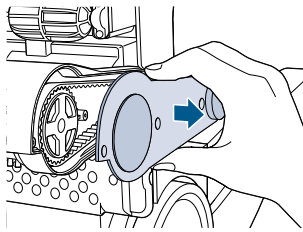

5. Lift and remove to access brush carriage.

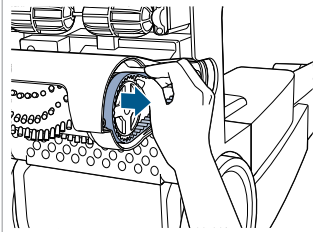

6. Turn the belt inward towards the large pulley while lifting out.

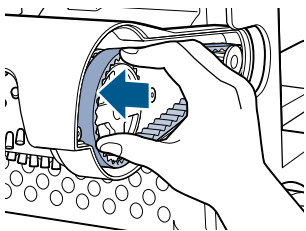

7. Place new belt over small pulley first and then slip the belt over the large pulley.

Note: Test the Brush Roll to make sure it spins freely before moving to the next step.

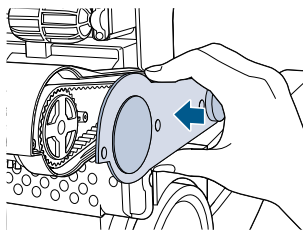

8. Replace the brush carriage and screws.

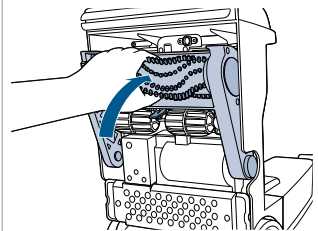

9. Push brush carriage back into place making sure the carriage latch locks back into place.

⚠ WARNING To reduce the risk of electric shock, turn Power Switch OFF and disconnect plug from electrical outlet before performing maintenance or troubleshooting checks.

Removing & Replacing the Brush Roll

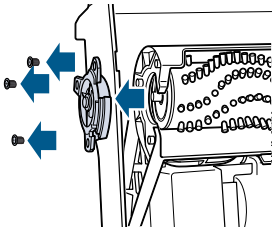

1. Remove three screws from endcap. Pull endcap off to release Brush Roll. With cover removed, the brush comes out easily by tilting the loose end out of the carriage.

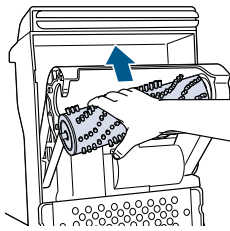

2. To replace the Brush Roll back into the machine, place the large open end of the brush onto the carriage and tilt opposite end back into place.

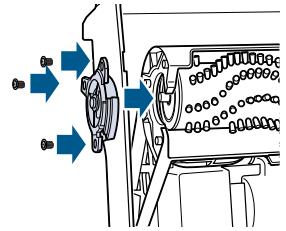

3. With the brush sitting relatively straight up and down by itself, place endcap back on top and replace three screws. The brush will need to be held and centered to the cover while placing it back on.

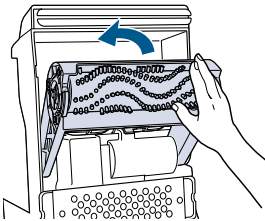

4. Spin the brush by hand to make sure it turns freely with some minor resistance from the motor. Push brush carriage back into place with a light pull against the lock.

⚠ WARNING To reduce the risk of electric shock, turn Power Switch OFF and disconnect plug from electrical outlet before performing maintenance or troubleshooting checks.

Storing Your Machine

👉 For more helpful maintenance tips, check out support.BISSELL.com.

Once your cleaning is complete, make sure both the Dirty and Clean Water Tanks are emptied, rinsed out and dried before the next use. Store cleaner in a protected, dry area.

Troubleshooting

🔧 Below are some of the issues you may run into. If you don't see the issue you're experiencing below, visit support.BISSELL.com.

Problem	Possible Cause	Remedies
Reduced or no spray	Clean Water Tank may be empty.	Fill Clean Water Tank with hot tap water.
	Tank may not be seated completely.	Turn power OFF. Remove and reseal tank.
	Pump may have lost prime.	Turn power OFF and then back ON. Wait one minute, then press trigger.
	Debris filter on base is clogged.	Turn power OFF. Use hand to remove debris.
DirtLifter® PowerBrush does not turn	The belt is off or broken.	Turn power OFF and unplug machine from outlet. Follow instructions on page 8.
	The machine is in the upright position.	Brushes only rotate when machine is reclined using the recline handle.
	Circuit breaker on machine may have tripped.	Turn the machine OFF and unplug from outlet. Check to see if foreign object is caught in Brush Roll. Remove object. Plug machine in to reset circuit breaker.
Cleaner not picking up solution	Tanks may not be seated properly.	Turn the machine OFF. Pick up both the Clean and Dirty Water Tanks and reseal them so they fit snugly on the machine.
	Clean Water Tank is empty.	Check fluid levels in Clean Water Tank and refill if necessary.
	Dirty Water Tank has picked up the maximum amount.	Empty Dirty Water Tank.
	Red float "door" in the tank may have closed as a result of bumping an object or moving machine back and forth too quickly.	Turn the machine OFF, allowing red float door to release into the open position. Turn the machine back ON to continue cleaning. Be sure your forward and backward strokes are completed at a slower pace.
	Front nozzle of machine is clogged.	Turn the machine OFF. Use fingers to remove any debris from this area.
	Upper body filter is clogged.	Turn the machine OFF. Use fingers to remove any debris from this area.

NOTICE To reduce the risk of a leaking condition, do not store unit where freezing may occur. Damage to internal components may result.

⚠️ WARNING To reduce the risk of electric shock, turn power OFF and disconnect plug from electrical outlet before performing maintenance or troubleshooting checks.



We're Waggin' Our Tails!

BISSELL® proudly supports BISSELL Pet Foundation® and its mission to help save homeless pets. When you buy a BISSELL product, you help save pets, too. We're proud to design products that help make pet messes, odors and pet homelessness disappear.

Visit [BISSELLsavespets.com](https://www.bissellsavespets.com) to learn more.

But wait, there's more!

Join us online for a complete guide to your new product, including troubleshooting, product registration, parts, and more.

Go to [support.BISSELL.com](https://support.bissell.com).



REGISTER



INFO



VIDEOS



PARTS



SUPPORT



©2020 BISSELL Inc. All rights reserved.
Part Number 1624684 04/20 RevF